



N-Channel Enhancement Mode Field Effect Transistor

Product Summary

V_{DS}	30V
I_D	4A
$R_{DS(ON)}$ (at $V_{GS}=10V$)	36m
$R_{DS(ON)}$ (at $V_{GS}=4.5V$)	60m

General Description

Trench Power MV MOSFET technology
High Power and current handing capability
Moisture Sensitivity Level 1
Epoxy Meets UL 94 V-0 Flammability Rating
Halogen Free

Applications

PWM application
Load switch

Absolute Maximum Ratings ($T_A=25$ unless otherwise noted)

Parameter		Symbol	Limit	Unit
Drain-source Voltage		V_{DS}	30	V
Gate-source Voltage		V_{GS}	± 20	V
Drain Current	$T_A=25$	I_D	4	A
	$T_A=100$		2.5	
Pulsed Drain Current ^A		I_{DM}	20	



YJL2304B

RECOMMEND
YJL2304A
FOR NEW DESIGN

Electrical Characteristics ($T_J=25$ unless otherwise noted)

Parameter	Symbol	Conditions	Min	Typ	Max	Units
Static Parameter						
Drain-Source Breakdown Voltage	BV_{DSS}	$V_{GS}=0V, I_D=250\mu A$	30	-	-	V
Zero Gate Voltage Drain Current	I_{DSS}	$V_{DS}=30V, V_{GS}=0V$	-	-	1	μA
		$V_{DS}=30V, V_{GS}=0V, T_J=150$	-	-	100	
Gate-Body Leakage Current	I_{GSS}	$V_{GS}=\pm 20V, V_{DS}=0V$	-	-	± 100	nA
Gate Threshold Voltage	$V_{GS(th)}$	$V_{DS}=V_{GS}, I_D=250\mu A$	1	1.6	2.2	V
Static Drain-Source On-Resistance	$R_{DS(ON)}$	$V_{GS}=10V, I_D=4A$	-	28	36	m
		$V_{GS}=4.5V, I_D=3A$	-	46	60	
Diode Forward Voltage	V_{SD}	$I_S=4A, V_{GS}=0V$	-	0.9	1.2	V
Gate resistance	R_G					

Typical Electrical and Thermal Characteristics Diagrams

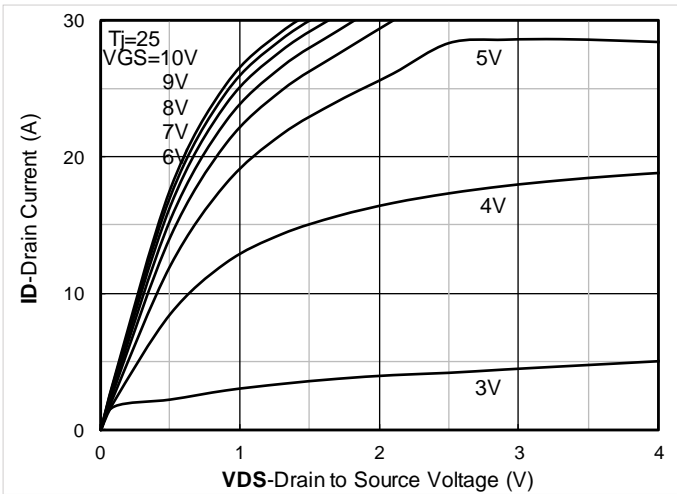

Figure 1. Output Characteristics

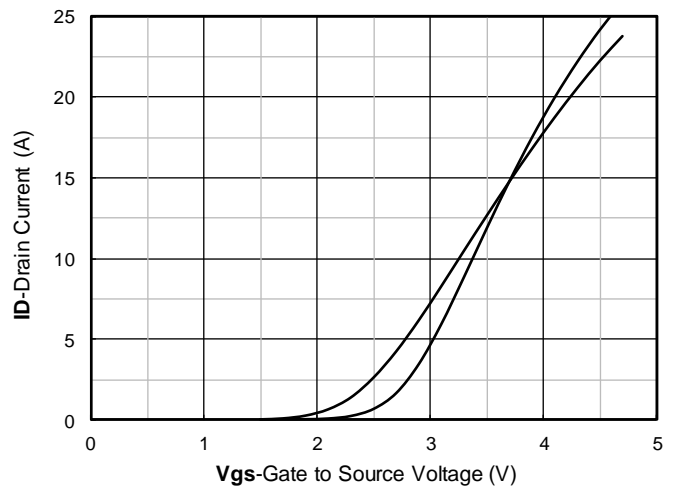

Figure 2. Transfer Characteristics

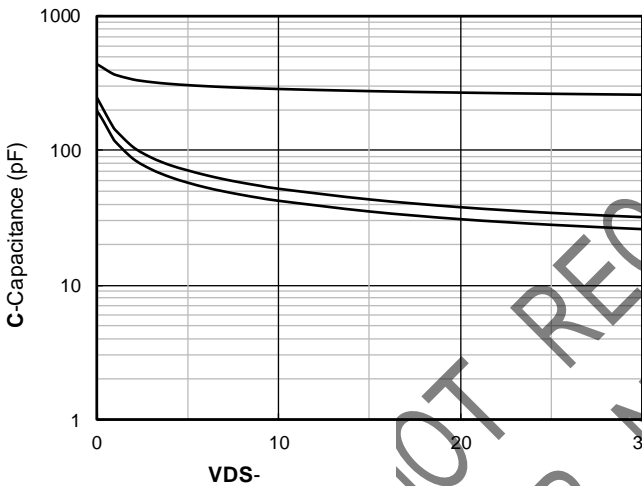

Figure 3. Capacitance Characteristics

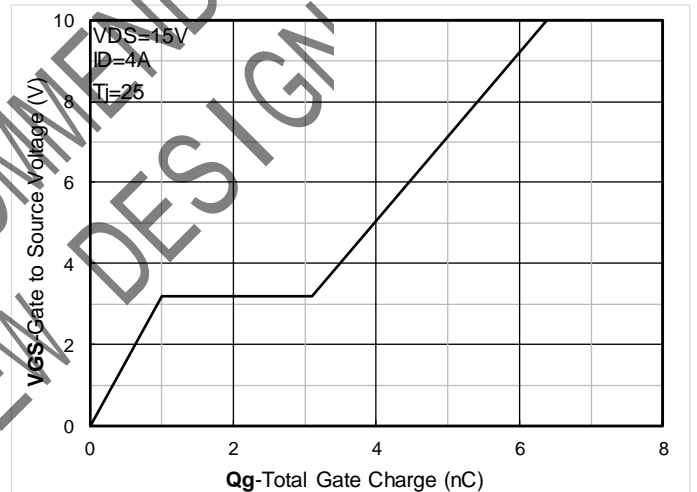

Figure 4. Gate Charge

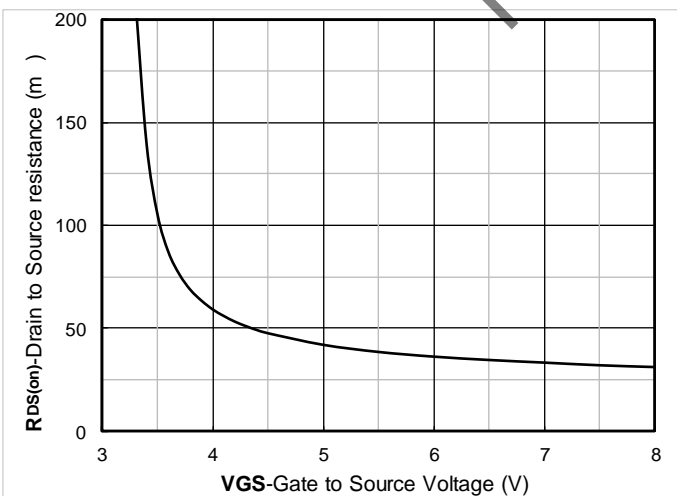

Figure 5. On-Resistance vs Gate to Source Voltage

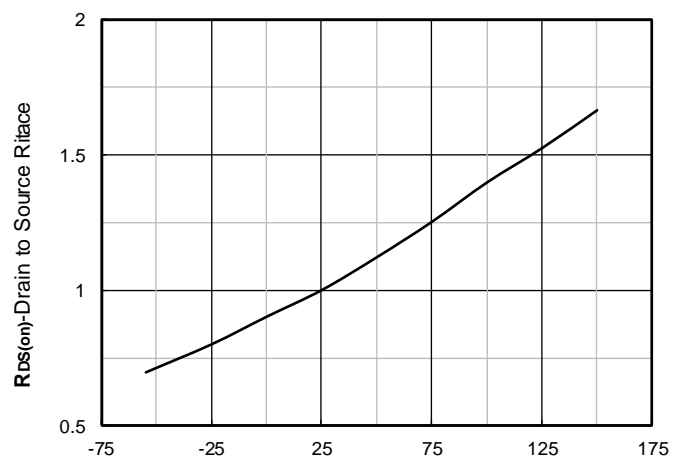

Figure 6. Normalized On-Resistance

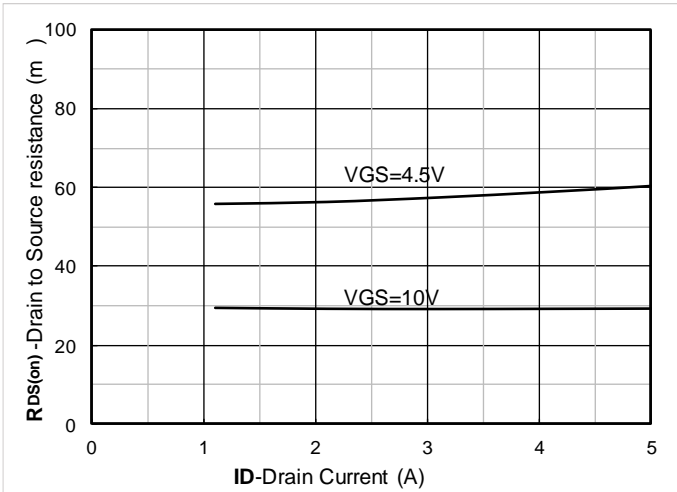

Figure 7. RDS(on) VS Drain Current

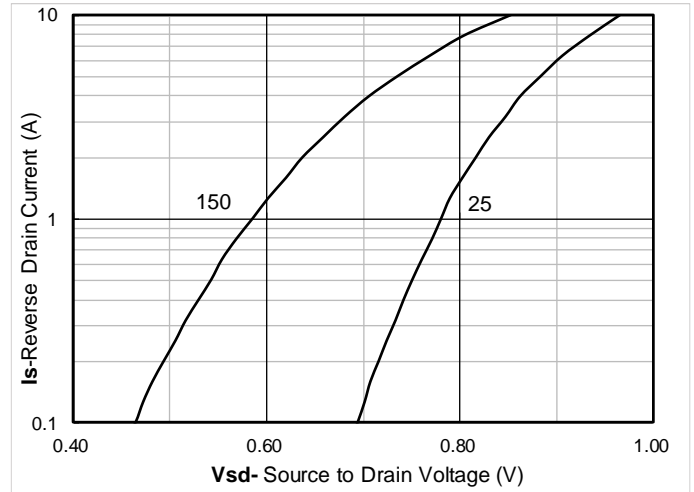

Figure 8. Forward characteristics of reverse diode

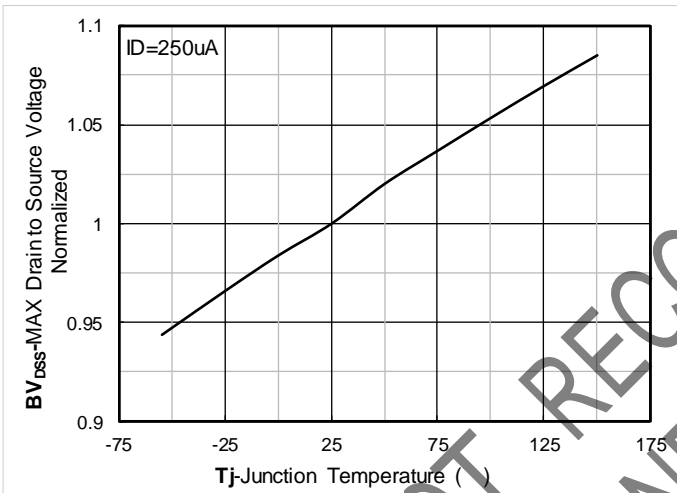

Figure 9. Normalized breakdown voltage

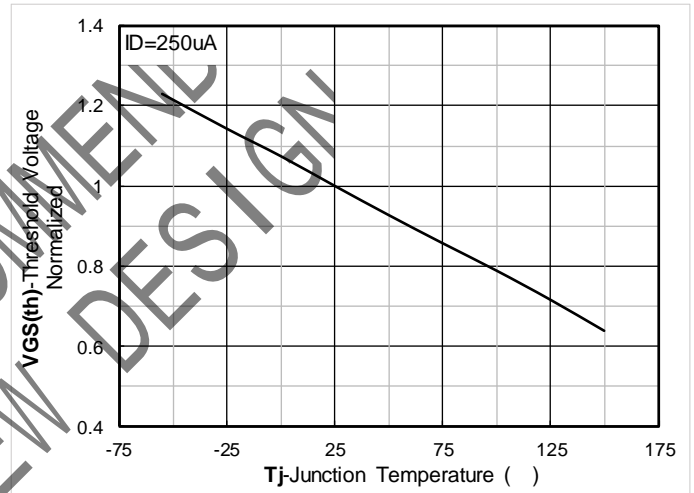

Figure 10. Normalized Threshold voltage

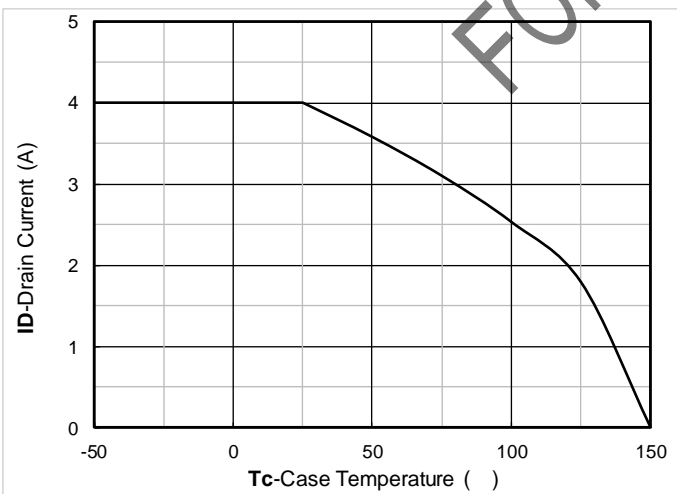

Figure 11. Current dissipation

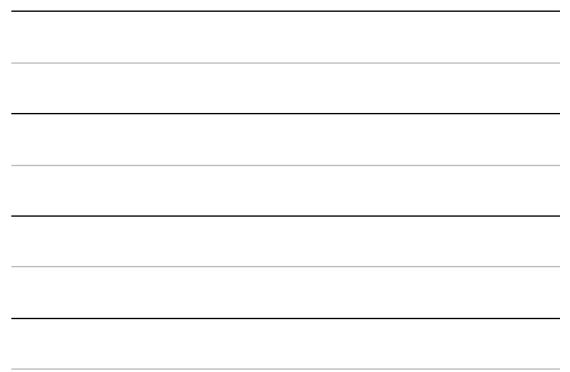

Figure 12. Power dissipation

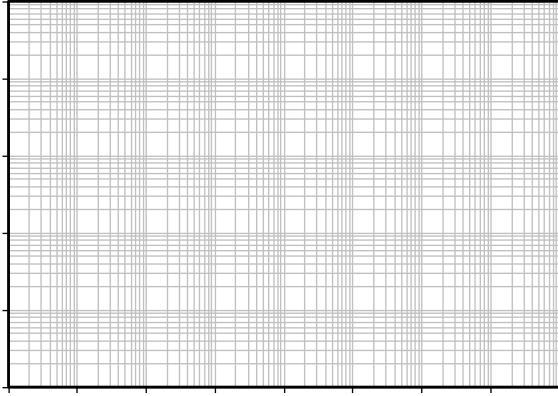

Figure 13. Maximum Transient Thermal Impedance

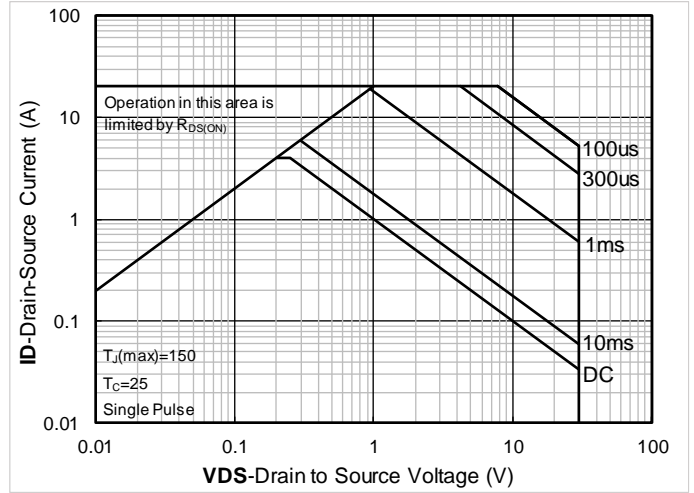

Figure 14. Safe Operation Area

Test Circuits & Waveforms

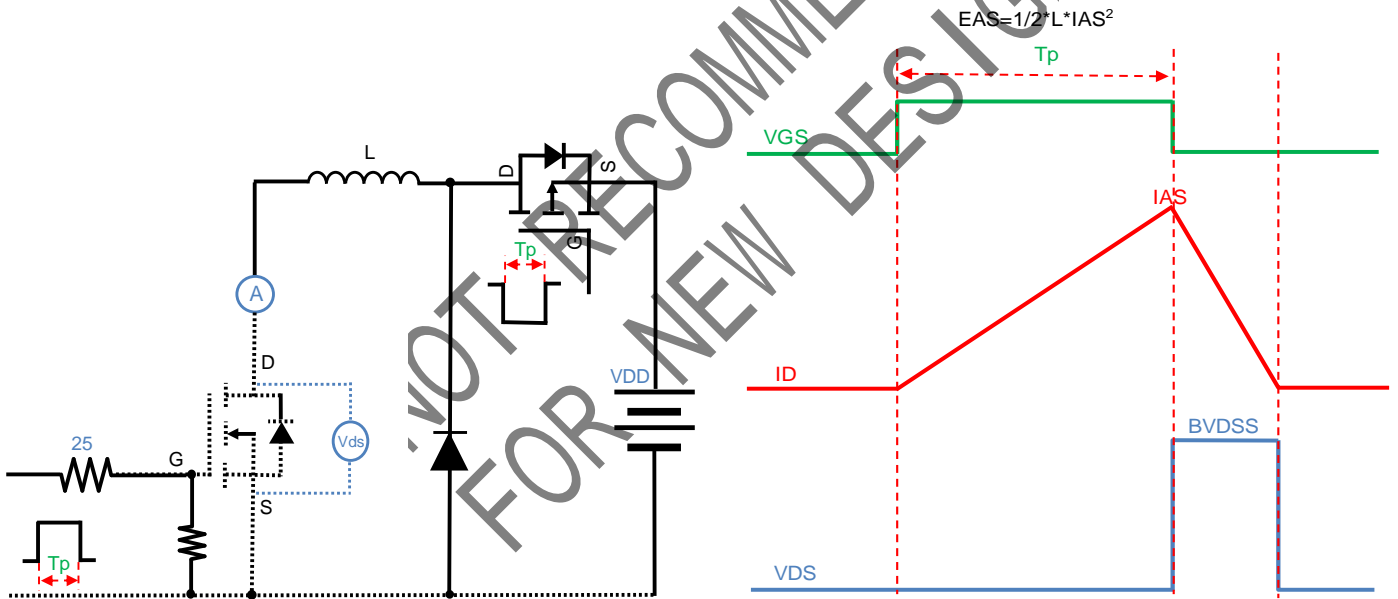
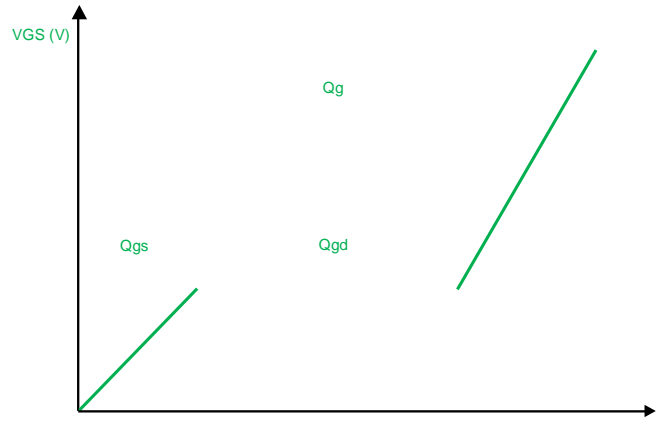
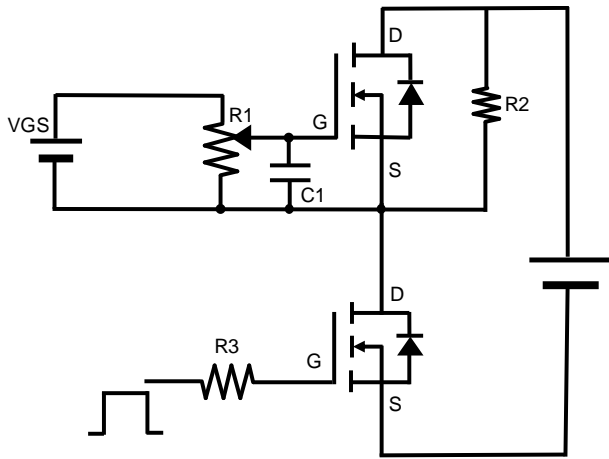

Figure A. Unclamped Inductive Switching (UIS) Test Circuit & Waveform



YJL2304B

RECOMMEND
YJL2304A
FOR NEW DESIGN



YJL2304B

RECOMMEND
YJL2304A
FOR NEW DESIGN

